

# 7/16 SERIES

## MEDIUM SIZED CONNECTORS



### Description

Jy Chyun 7/16 series connectors are featured with superior performance for return loss and inter-modulation distortion. These connectors are ideal for those applications where vibration resistance and environmental protection is important, such as radio base station and broadcast communication application.

### Applications

- Antennas
- Base Stations
- Broadcast Communication Systems
- Jumper Cables

# Specifications

Electrical		Material		
Impedance	50 ohm	Parts Name	Material	Finish
Frequency Range	0-7.5GHz	Body, metal parts	Brass per QQ-B-626	Silver
Working Voltage	2700 VRMS max. at sea level	Center Contacts	Plug: Brass per QQ-B-626 Jack: Beryllium copper per QQ-C-530	
Dielectric Withstanding Voltage	4000 VRMS min. at sea level	Insulators	PTFE	None
VSWR	Straight: 1.3 max.	Gasket	Silicone	None
	Right Angle: 1.5max	Crimp Ferrules	Annealed copper	Silver
Contact Resistance	Center Contact: 0.4 Milliohms Max. Outer Contact: 0.2 Milliohms Max.	Note : Other Material / Finish is Available on Request.		
Insulation Resistance	5000 megohms min.	Mechanical		
		Coupling Nut Retention	225 lbs.min.	
		Coupling Proof Torque	310 in.-lbs.min.	
		Contact Retention	45 lbs.min.	
		Durability (Mating)	500 cycles min.(for Beryllium copper female contact only)	

# Interface Mating Dimensions

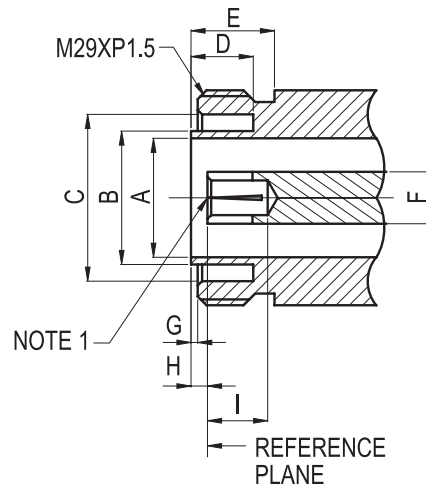
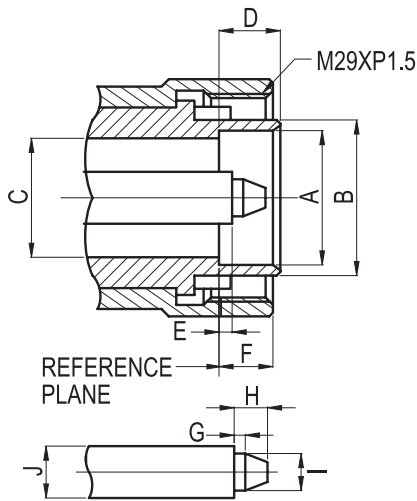

PLUG		
Letter	Millimeters	
	Minimum	Maximum
A	18.03(.710)	18.21(.717)
B	20.60(.811)	21.40(.843)
C	15.85(.624)	16.25(.640)
D	7.00(.276)	8.00(.315)
E	1.47(.058)	1.77(.070)
F	7.00(.276)	9.00(.354)
G	1.40(.055)	1.60(.063)
H	-	4.50(.177)
I	4.96(.195)	5.04(.198)
J	6.97(.274)	7.03(.277)

JACK		
Letter	Millimeters	
	Minimum	Minimum
A	15.85(.624)	16.25(.640)
B	-	18.00(.709)
C	22.10(.870)	22.90(.902)
D	8.10(.319)	-
E	10.00(.394)	-
F	6.97(.274)	7.03(.277)
G	0.50(.020)	0.70(.028)
H	1.77(.070)	2.07(.081)
I	5.00(.197)	-

NOTE 1 : I.D. TO MEET VSWR AND CONTACT RESISTANCE WHEN MATED WITH 4.96/5.04 MM DIA. PIN.

## Flexible Cable

STRAIGHT PLUG, Crimp

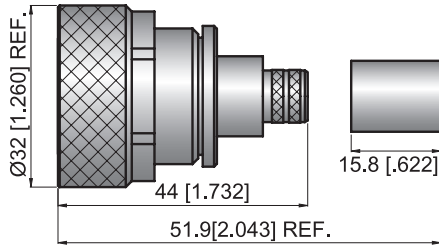

Part Number.	Cable Type	Dimension	
		A	B
7/16-C5611101R8	RG214		

## Flexible Cable

STRAIGHT JACK, Crimp

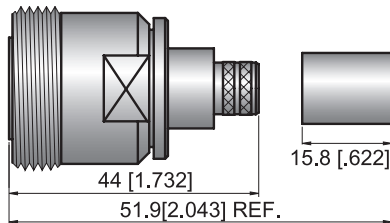

Part Number.	Cable Type	Dimension	
		A	B
7/16-C5711101R8	RG214		

## Flexible Cable

PANEL STRAIGHT JACK, Crimp

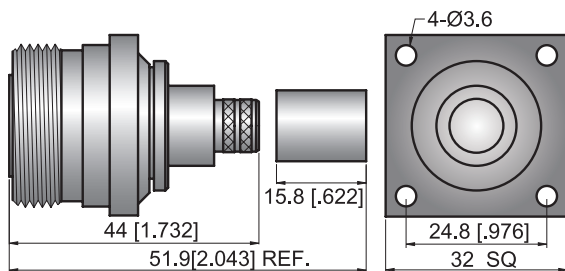

Part Number.	Cable Type	Dimension	
		A	B
7/16-C5715102R8	RG214		

## Flexible Cable

STRAIGHT PLUG, Clamp

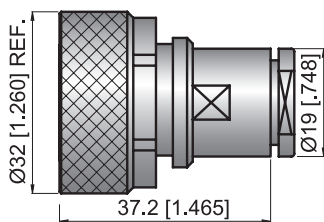

Part Number.	Cable Type	Dimension	
		A	B
7/16-C5617102R8	RG214		

**Flexible Cable**

STRAIGHT JACK, Clamp

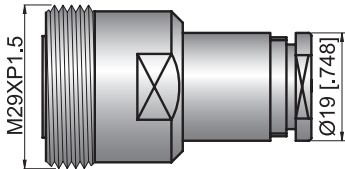

Part Number.	Cable Type	Dimension	
		A	B
7/16-C5717103R8	RG214		

**Flexible Cable**

RIGHT AGHLE PLUG, Clamp

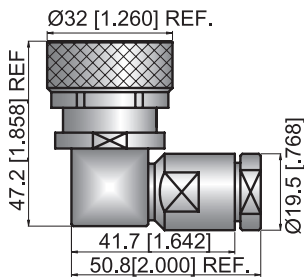

Part Number.	Cable Type	Dimension	
		A	B
7/16-C5627103R8	RG214		

**Panel Receptacle**

PANEL STRAIGHT JACK

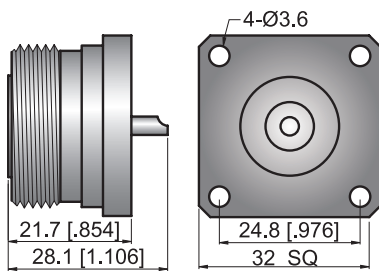

Part Number.	Cable Type	Dimension	
		A	B
7/16-C5715101Z0			